

Effect of Diamond Grinding on Noise Characteristics of Concrete Pavements in California

Shubham Rawool¹ and Richard Stubstad²

ABSTRACT

The construction of sound walls along highways has been the primary noise mitigation strategy in California and in many other western States. Sound walls cost approximately \$1.5 million per mile and are effective only in close proximity to the highway, on the “far” side of the sound wall, so to speak.

In its efforts to explore other noise mitigation strategies, the California Department of Transportation (Caltrans) recently conducted a study to determine the effect of diamond grinding on the noise characteristics of existing concrete pavements. Since the noise generated at the tire–pavement interface is the greatest contributor to highway noise, quieter pavement surfaces can reduce overall noise levels for both road users and neighborhoods—whether sound walls are used or not.

On-board sound intensity (OBSI) measurements were conducted on six routes in California, for a total of 42 evaluation sections; each evaluation section was 440 ft (136.8 m) long. OBSI measurements before and after diamond grinding were recorded. Following are the overall conclusions that were reached after the pre- and post-grinding OBSI levels were measured:

- There is a significant and readily audible reduction in OBSI levels (and hence in tire–pavement noise) after grinding.
- An average 2.7 dBA reduction in OBSI levels was observed for all test sites.
- Among the six routes, the highest average reduction of 4.4 dBA was observed on I-5 near Richards Boulevard in Sacramento County, and the lowest reduction of 1.2 dBA was observed on State Route 60 (on a single test section) in San Bernardino County.
- The highest reductions in sound intensity levels on a 1/3-octave band basis occurred in the 1600 Hz band, while the lowest reductions occurred in the 1000 Hz bandwidth.

INTRODUCTION

The construction of sound walls along highways has been the primary noise mitigation strategy in California and many other States. Since the sound walls have their own limitations, other strategies which could be used in conjunction with the sound walls are investigated. Among the strategies that can reduce noise levels and sustain them while maintaining durability, maintain-

¹ Shubham Rawool, Applied Research Associates, Inc., 1111 Howe Avenue, Suite 540, Sacramento, CA 95825; email: srawool@ara.com; phone: 916-920-9850.

² Richard Stubstad, Applied Research Associates, Inc.; email: rstubstad@ara.com; phone: 916-920-9850

ability, and friction is improving pavement surface characteristics during construction or diamond grinding the concrete surface post-construction. Efforts are underway to determine the optimum surface characteristics that would simultaneously address tire pavement noise, texture, smoothness, and friction.

In its effort to develop newer noise mitigation strategies, the California Department of Transportation (Caltrans) is evaluating various alternatives that can reduce highway noise, even in existing portland cement concrete pavement (PCCP). Since the noise generated at the tire–pavement interface is the greatest contributor to highway noise, quieter pavement surfaces can reduce the overall noise levels substantially for road users and neighborhoods alike. The noise-reducing capabilities of open-graded asphaltic mixtures, porous concrete, and diamond-ground pavement surfaces are some of the alternative approaches that are being considered to reduce tire–pavement interface noise.

Grinding on bridge decks and elevated structures has been found to reduce tire–pavement source levels by 3 to 10 “average weighted decibels” (dBAs), with relatively comparable reductions in wayside noise measurements (Ref. 1). Also, in Arizona, diamond grinding of transversely tined concrete surfaces has been found to reduce pavement interface source levels by up to 9 dBAs (Ref. 1). Similar results were also obtained in a study conducted on Route 101 in California. Average noise-level measurements and single-vehicle pass-by (not pavement interface) values were used to determine the reduction in noise levels after diamond grinding. Although the results of the average noise levels were found to be inconclusive, the results of the pass-by noise-level measurements showed an average noise drop of approximately 6 dB at 25 ft and 4 dB at 50 ft (Ref. 2). Considering this potential level of noise reduction, it can be concluded that diamond grinding of concrete surfaces may be a feasible means of reducing noise levels on existing PCCP.

Objective of the Study

The main objective of the Caltrans study was to determine the effect of diamond grinding on the tire–pavement noise characteristics of PCCP. Existing tire–pavement noise characteristics of in-service pavements were determined both before and after grinding. The study had the following specific objectives:

- Conduct on-board sound intensity (OBSI) measurements to determine tire–pavement noise levels on PCCP sections before and after diamond grinding.
- Compare these before-and-after OBSI results to determine the change in sound intensity (SI) levels after grinding.
- Select candidate PCCP sections to monitor long-term noise characteristics.

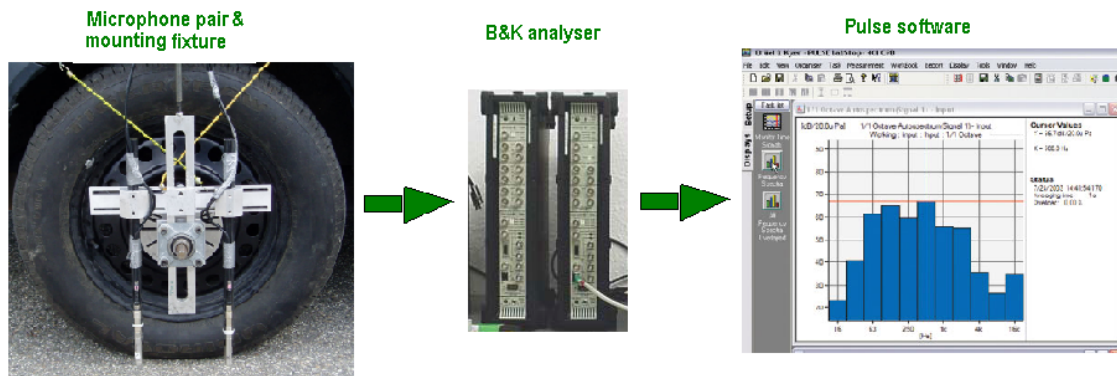

Figure 1. OBSI equipment setup.

DATA COLLECTION

OBSI Equipment

The OBSI method was used to measure tire–pavement interface noise. The equipment setup used to conduct measurements consisted of a Bruel and Kjaer front-end analyzer and the associated “Pulse” software package, two probes (each consisting of a microphone pair), a mounting fixture, and a Michelin Standard Reference Test Tire (SRTT—see Figure 1).

Each probe has two 0.5 in. (13 mm) diameter, phase-matched condenser microphones spaced 0.625 in. (16 mm) apart and fitted with a wind screen (Figure 2).

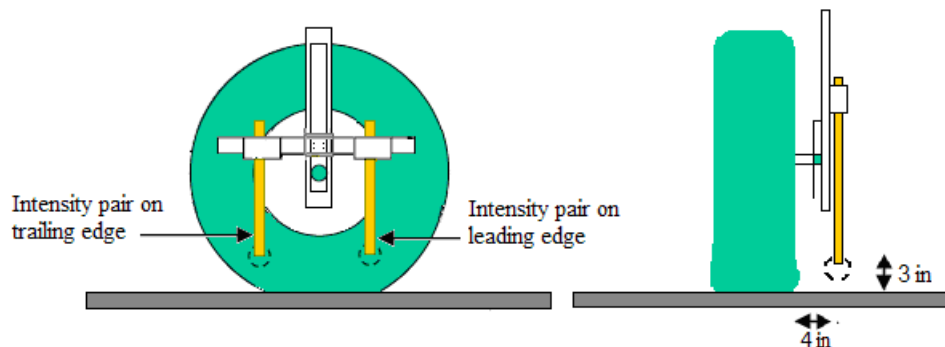

Figure 2. Schematic diagram depicting the microphone setup.

The two probes are placed 3 in. (76 mm) above the pavement and 4 in. (102 mm) away from the tire sidewall and are positioned to capture SI at the leading and trailing edges of the tire contact patch (Figure 2). The SI at the two probes is captured simultaneously by the front analyzer in real time and can be viewed on an onboard computer using the Pulse software. The intensity values at the leading and trailing edges of the tire contact area are averaged together on an energy basis to determine the SI for a given pavement section.

Testing Procedure

The test vehicle was driven at a constant speed using the cruise control. For each route, test sections with minimum grade and alignment changes were selected. Tests were conducted at times when traffic was sparse and on days when dry pavement and favorable wind conditions were present. To limit the data to as few variables as possible, a test plan with the following parameters was developed:

- Constant speed of 60 ± 2 mi/h ($97 \pm$ km/h).
- Michelin Standard Reference Test Tire (SRTT).
- Cold tire pressure 30 lbf/in² (206.8 kPa).
- No significant grade.
- Dry pavement.

To reduce any bias caused by the equipment; microphones, preamplifiers, and cords were numbered and placed in the same location for each test. Before and after every test, each of the four microphones was calibrated.

Test Sections

All pavement sections considered for this project are listed in Table 1. Caltrans originally identified 15 routes on which pre-grind OBSI measurements were conducted. A total of 81 evaluation sections, each of 5-second duration (440 ft [134 m]), were measured using the OBSI testing equipment.

Since some of the pavements remained unground by the time this study ended, only 6 of the original 15 routes (consisting of several test sections on each route) could be tested for post-grind noise levels. However, these included over half (42 out of 81) of the evaluation sections originally surveyed in the pre-grind phase of the project. All the evaluation sections except one (along I-60 southbound) showed a reduction in SI after grinding. The section on SR 60 beginning at postmile (PM) 7.9 was excluded from analysis because it was not considered typical.

Table 2 and Figure 3 show pre- and post-grind SI values for the six routes. There was a reduction in SI on all the routes after grinding. The greatest reduction in SI value—4.4 dBA—was observed on I-5 in Sacramento County, and the lowest reduction (1.2 dBA) was observed on State Route 60 in San Bernardino County. On average, the reduction for all six sites was 2.7 dBA—a significant and audibly noticeable improvement.

**Table 1
Details of Tested Routes**

Site No.	Route	County	Starting Postmile	Ending Postmile	No. of Tested Sections (440 ft)	Date of Pre-grind Testing	Date of Post-grind Testing
1	I-5	LA	32.3	44.3	7	5/22/2007	Not ground
2	I-10	LA	18.3	32.7	7	5/22/2007	Not ground
3	SR-60	LA	23.9	30.4	3	5/8/2007	Not ground
4	SR-60	SBD	0	9.9	2	5/8/2007	6/4/2008
5	I-15	SBD	0	3.8	4	5/9/2007	Not ground
6	I-15	RIV	51.4	52.3	2	5/9/2007	Not ground
7	I-10	RIV	0	8.2	4	5/9/2007	Not ground
8	I-15	RIV	8.1	23.9	6	5/23/2007	6/5/2008
9	SR-91	RIV	0	9.0	4	5/10/2007	Not ground
10	I-5	ORA	14.5	21.3	4	5/23/2007	6/5/2008
11	I-405	ORA	16.9	24.2	3	5/22/2007	6/5/2008
12	SR-101	SFO	0	4.2	1	5/06/2007	Not ground
13	I-280	SCL	5.1	7.8	4	5/06/2007	Not ground
14	I-5	KER	10.2	15.8	14	4/16/2008	5/17/2008
15	I-5	SAC	24.1	24.8	16	5/19/2008	7/24/2008

**Table 2
Pre- and Post-grind SI Values From All Six Routes**

Site No.	Route Name	County	Pre-Grind SI (dBA)	Post-Grind SI (dBA)	After Grind Reduction (dBA)
1	SR-60	SBD	105.1	103.9	1.2
2	I-15	RIV	103.9	101.8	2.1
3	I-5	ORA	104.0	101.3	2.6
4	I-405	ORA	104.4	102.0	2.5
5	I-5	KER	103.2	100.0	3.2
6	I-5	SAC	104.7	100.3	4.4
Average			104.2	101.5	2.7

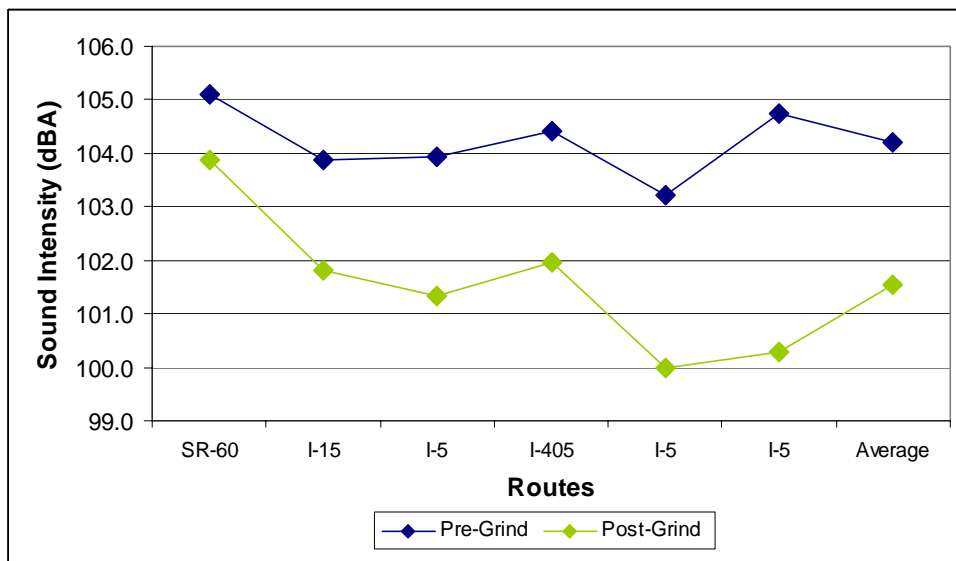

Figure 3. Pre- and post-grind SI values for all six routes.

Detailed Data Analysis for I-5 in Kern County

A detailed analysis was conducted on the I-5 project in Kern County. This site was chosen for detailed analysis since it had the most evaluation sections among all sites tested. Also, the data on this site were considered to be most representative to study the detailed effect of grinding on SI levels because pre- and post-grind data were collected within a 1-month period of one another.

On this route, data were collected in both the northbound and southbound directions. In the northbound direction, five consecutive 440-ft (134-m) sections starting at PM 11.8 were measured. Similarly, in the southbound direction, nine consecutive 440-ft (134-m) sections starting at PM 12.3 were measured.

SI Levels for I-5 in Kern County

A comparison of the pre- and post-grind SI levels is shown in Figure 4 and Figure 5 for the southbound and northbound directions of traffic, respectively. The average pre-grind noise level in the southbound direction was 102.8 dBA, whereas in the northbound direction it was 104.0 dBA. Correspondingly, the average post-grind noise levels were 100.1 dBA and 100.0 dBA in the southbound and northbound directions, respectively.

Note that the average pre-grind noise level was approximately 1 dBA higher in the northbound direction compared to southbound direction. After grinding, a reduction of 3.9 dBA northbound and 2.9 dBA southbound was observed (Figure 6). The average post-grind SI level for this site was 100 dBA. This means that the results in terms after-grind dBA were similar, regardless of the initial noise level.

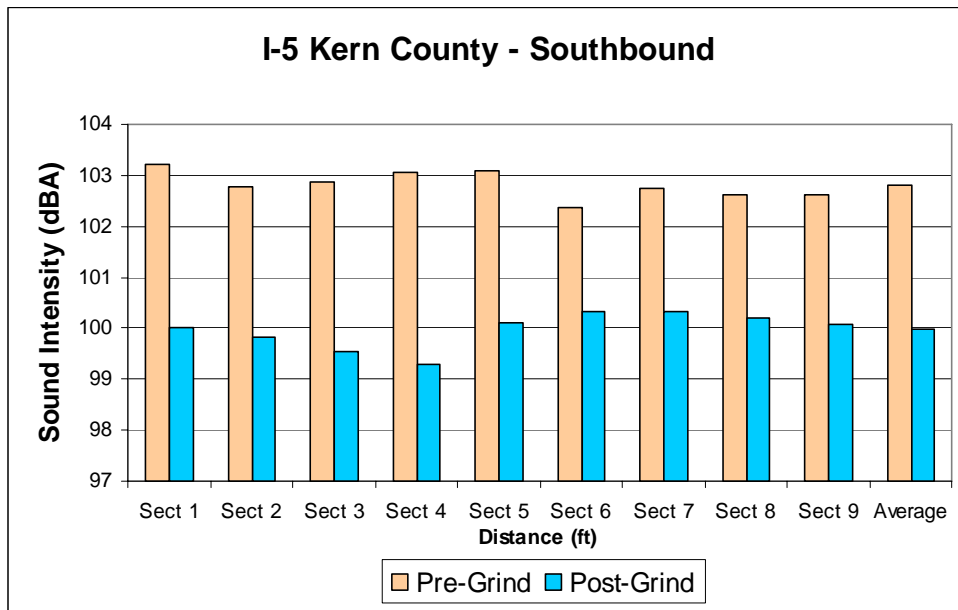

Figure 4. A-weighted SI levels averaged over four runs for southbound I-5 in Kern County.

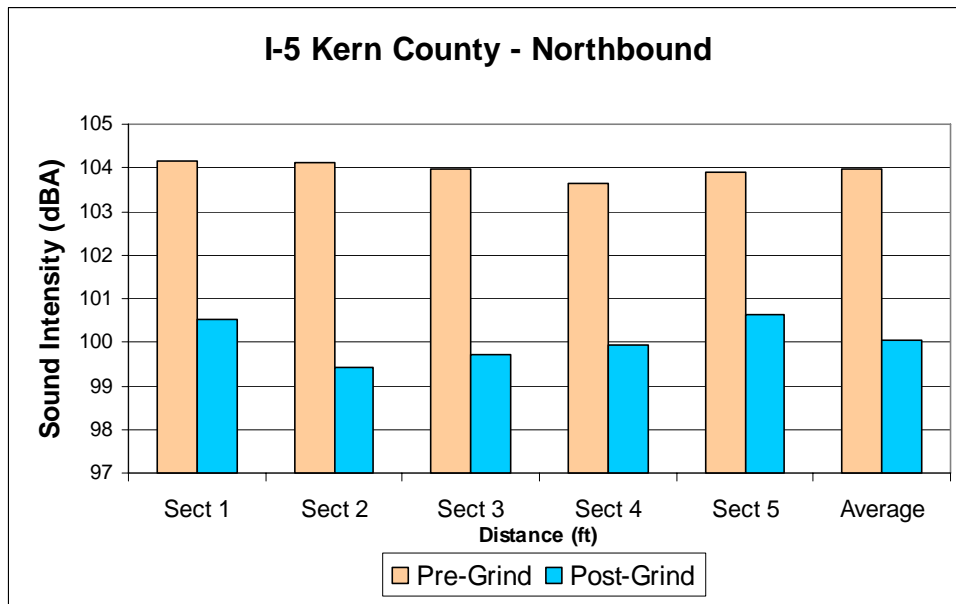

Figure 5. A-weighted SI levels averaged over four runs for northbound I-5 in Kern County.

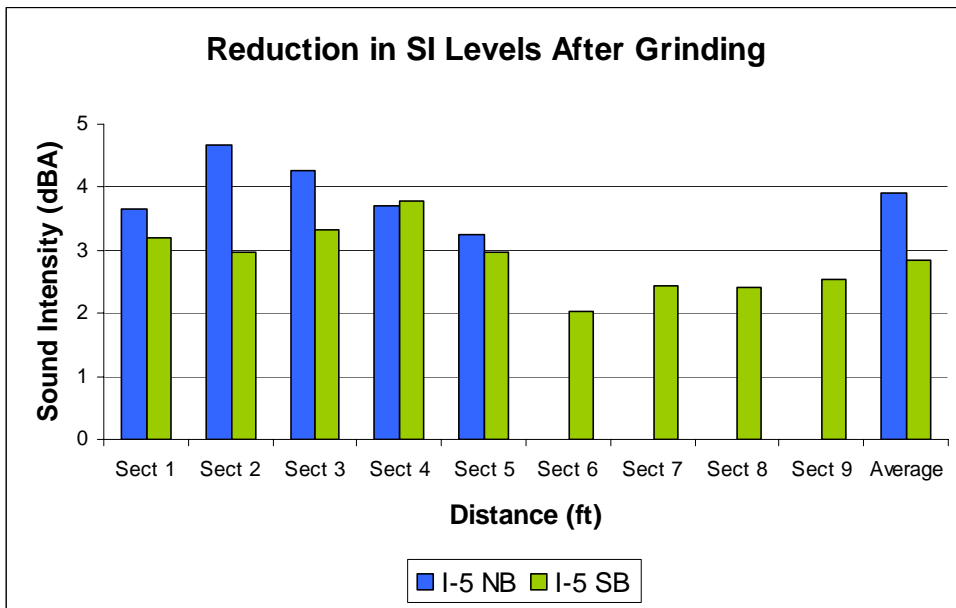

Figure 6. Reduction in noise levels after grinding on I-5 in Kern County.

1/3-Octave Analyses for I-5 in Kern County

One-third-octave band analyses of SI levels were also conducted to determine the consistency among runs and delineate the effect of grinding on the individual 1/3-octave bands.

Southbound Direction: Figure 7 and Figure 8 show pre- and post-grind center frequency bands from 500 Hz to 5000 Hz for all four runs on southbound I-5. In the figure, each run (Rx) is represented by three SI curves, the first curve for the microphone at the trailing edge (Tr) of the tire, the second for the microphone placed at the leading edge (Ld), and the third representing the average for the leading and trailing edge microphones. As shown in these figures, the consistency of SI values among runs is very clear in the 1/3-octave band analysis.

Pre- and post-grind SI values at 1/3-octave bands were compared to determine the effect of grinding on the various individual octave bands. Table 3 and Figure 9 show pre- and post-grind 1/3-octave band spectra comparisons for the southbound direction. The greatest reductions for the 1/3-octave bands occurred in the 1600 Hz band, while the lowest reduction was for bands between 500 and 1000 Hz. However, all octave bands showed significant reduction levels within audible frequencies.

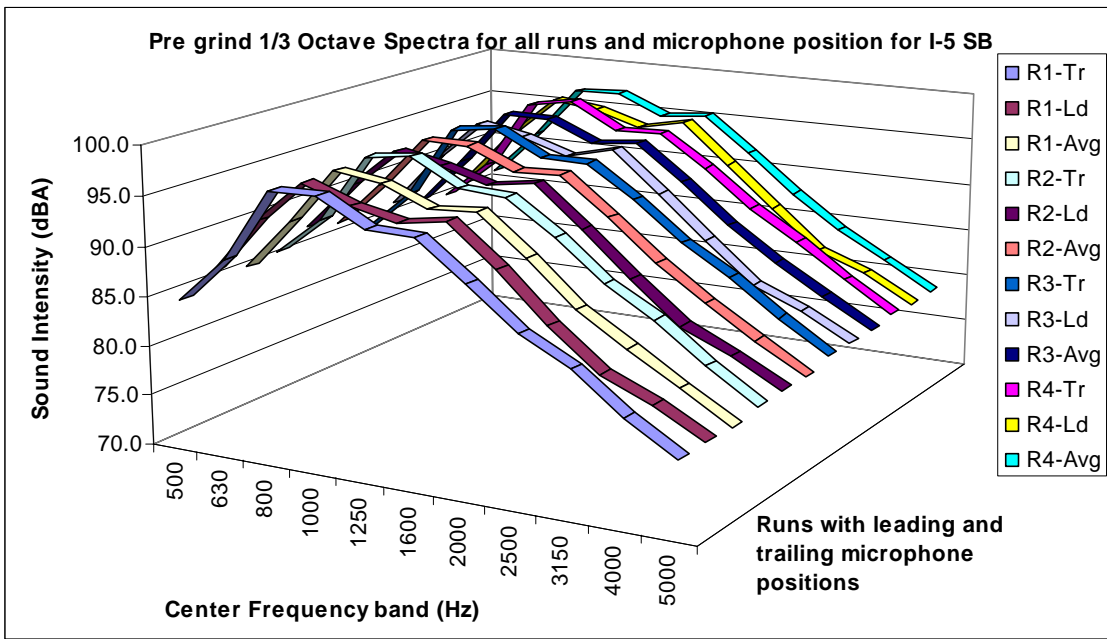

Figure 7. Pre-grind 1/3-octave band spectra for Southbound I-5 in Kern County.

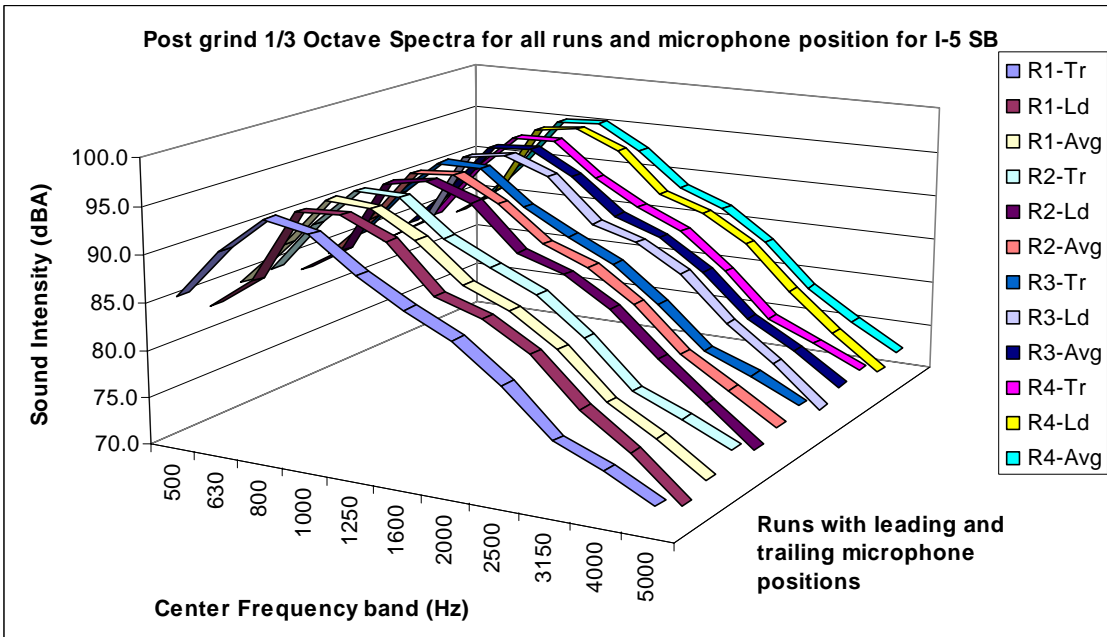

Figure 8. Post-grind 1/3-octave band spectra for Southbound I-5 in Kern County.

Table 3
SI Values for Various Center Frequency Bands on
Southbound I-5 in Kern County

Center Frequency Band (Hz)	Pre-Grind SI (dBA)	Post-Grind SI (dBA)	Difference in SI (dBA)
500	86.2	84.4	1.8
630	91.2	89.0	2.1
800	96.7	94.6	2.1
1000	96.6	94.8	1.8
1250	94.5	92.1	2.4
1600	94.9	88.3	6.6
2000	91.2	86.4	4.8
2500	87.1	83.2	4.0
3150	83.7	78.5	5.3
4000	80.8	75.4	5.4
5000	77.9	72.3	5.6

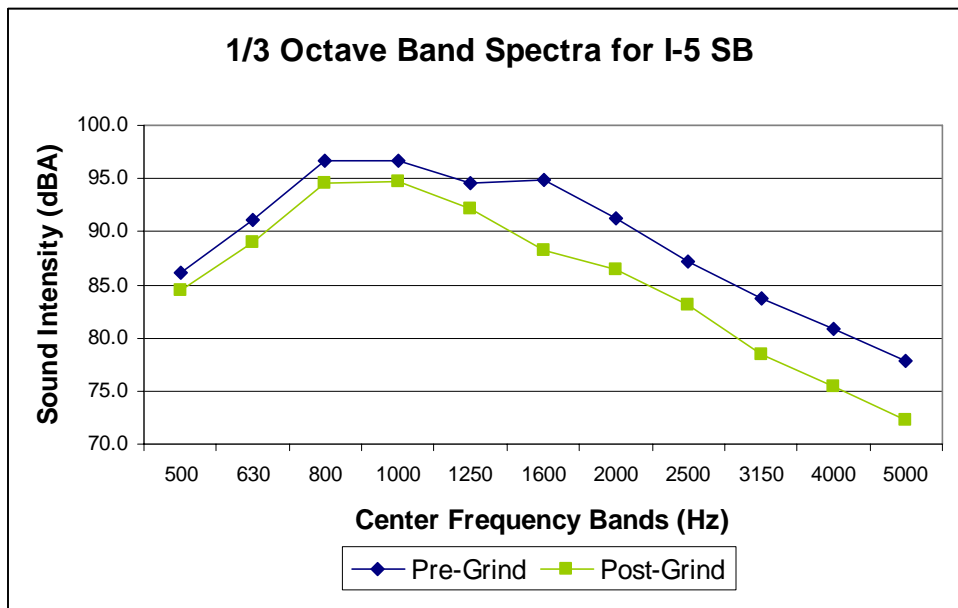

Figure 9. Pre- and post-grind 1/3-octave band spectra for northbound I-5 in Kern County.

Northbound Direction: Figure 10 and Figure 11 show pre- and post-grind frequency bands from 500 to 5000 Hz for all the runs on northbound I-5. Again, each run (Rx) is represented by three SI curves, one for the microphone at the trailing edge (Tr) of the tire, another for the microphone placed at the leading edge (Ld), and the third one representing the average of the leading and trailing edge microphones. The consistency of SI values among runs is clear in the 1/3-octave band analyses.

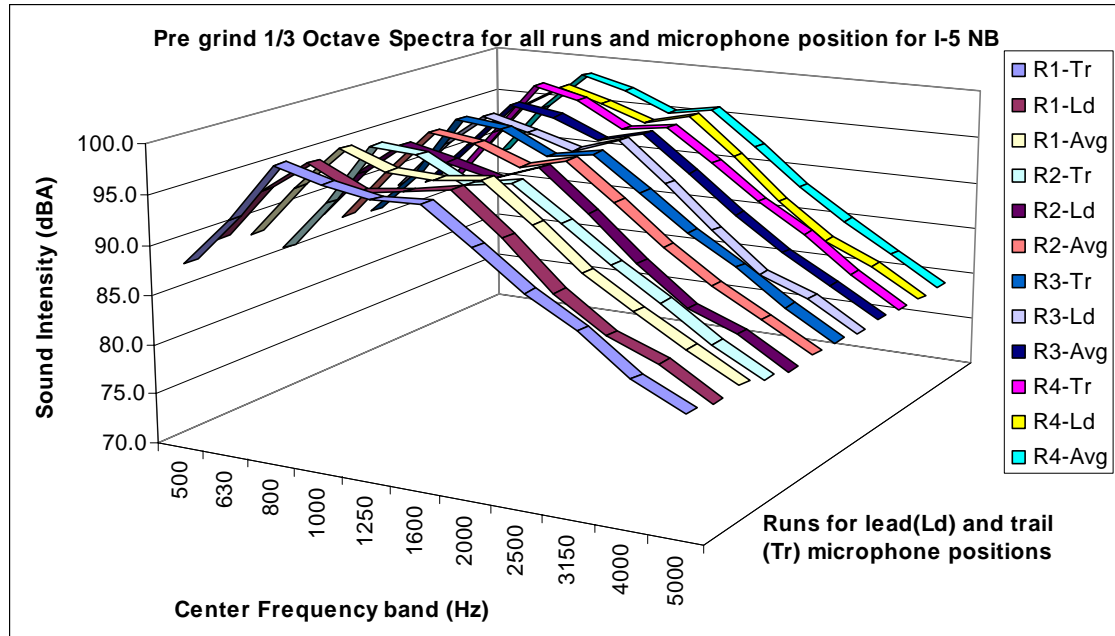

Figure 10. Pre-grind 1/3-octave band spectra for northbound I-5 in Kern County.

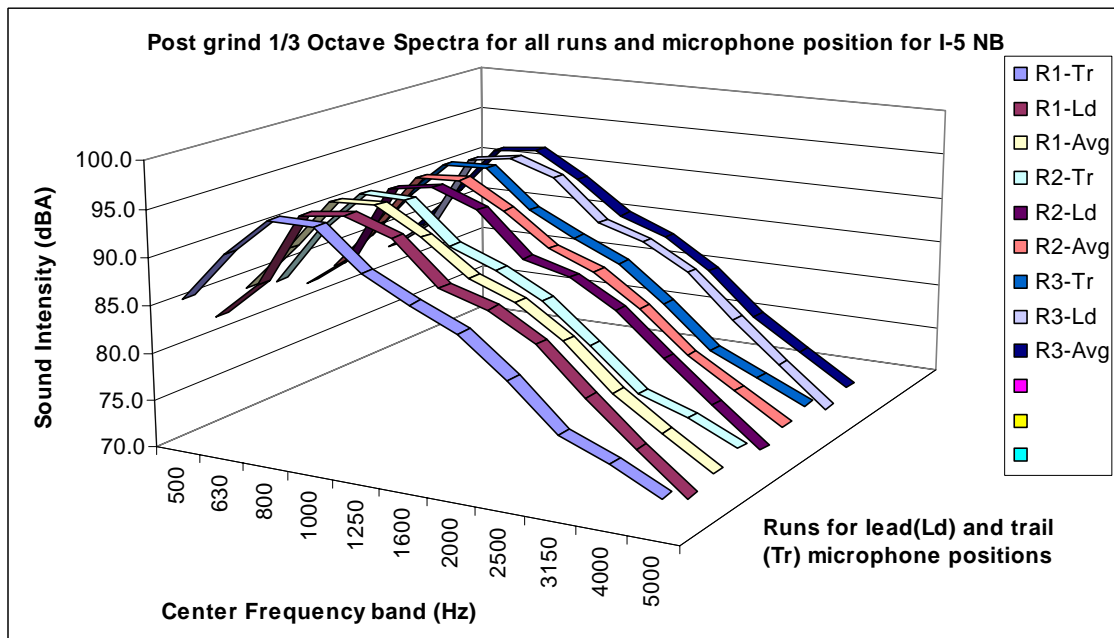

Figure 11. Post-grind 1/3-octave band spectra for northbound I-5 in Kern County.

Pre- and post-grind SI values at the 1/3-octave bands were compared to determine the effect of grinding on the respective octave bands. Table 4 and Figure 12 show pre- and post-grind 1/3-octave band spectra comparisons for the southbound direction of traffic. The greatest reductions on the basis of these 1/3-octave bands occurred in the 1600 Hz band, while the lowest reduction was in the 1000 Hz octave band. However, all octave bands showed significant reduction levels within audible frequencies.

Table 4
SI for Various Center Frequency Bands on Northbound I-5 in Kern County

Center Frequency Band (Hz)	Pre-Grind SI (dBA)	Post-Grind SI (dBA)	Difference in SI (dBA)
500	88.2	84.0	4.2
630	93.5	88.9	4.5
800	98.1	94.6	3.5
1000	96.9	94.9	2.0
1250	95.4	92.1	3.3
1600	96.4	88.6	7.8
2000	92.7	86.8	5.9
2500	88.7	83.6	5.1
3150	85.5	79.2	6.3
4000	82.6	76.0	6.7
5000	79.8	72.9	6.9

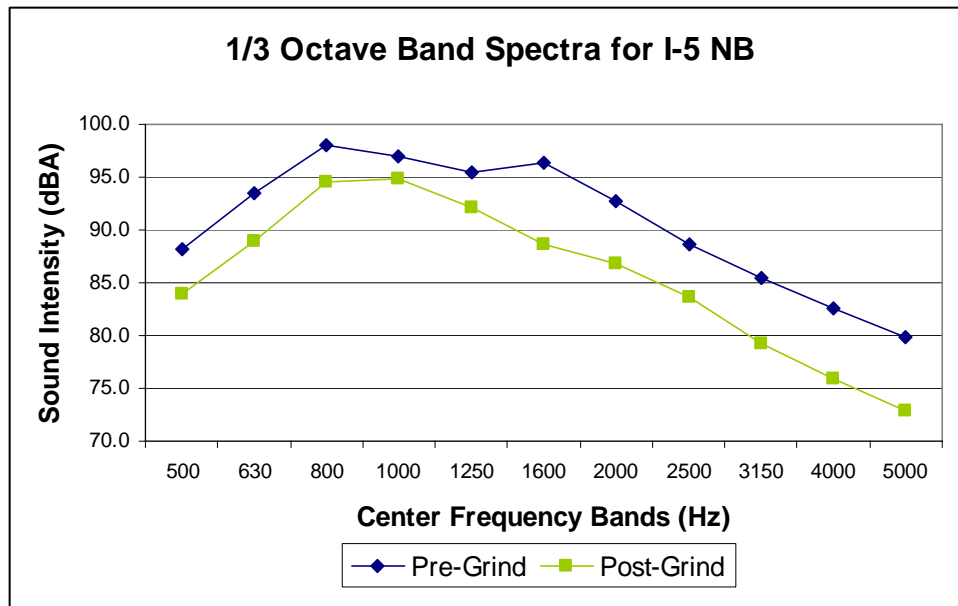

Figure 12. Pre- and post-grind 1/3-octave band spectra for southbound I-5.

CONCLUSIONS AND RECOMMENDATIONS

- There is a significant and easily audible reduction in SI levels (and hence in tire–pavement noise) after diamond grinding of PCC pavements.
- For the six routes on which pre- and post-grind data were available, the highest average reduction of 4.4 dBA was observed on I-5 near Richards Boulevard in Sacramento County, and the lowest reduction of 1.2 dBA was observed on State Route 60 (on a single test section) in San Bernardino County.
- An average 2.7 dBA reduction in SI levels was observed for all test sites.
- The highest reduction of 6.7 dBA, after grinding, for a single 440-ft (134-m) section was observed on I-5 in Sacramento County.
- The highest reductions in SI levels on a 1/3-octave band basis occurred in the 1600 Hz band, while the lowest reductions occurred in the 1000 Hz bandwidth. All octave bands showed significant reduction levels within audible frequencies.

It is therefore recommended:

- The long-term effect of grinding on tire–pavement noise should be monitored to determine the effectiveness of diamond grinding as a long-term strategy for noise mitigation in concrete pavements.
- All six routes, which consist of forty-two 440-ft (134-m) individual evaluation sections, should continue to be monitored to determine the progression of tire–pavement noise over a longer analysis period.

REFERENCES

1. “Quieting Concrete Pavement Through Surface Texture Design and Modification.” *R&T Update – Concrete Pavement Research and Technology*. American Concrete Pavement Association, August 2006.
2. Areg Gharabegian and Emery Tuttle. “Diamond Grinding for Roadway Noise Control.” *Sound and Vibration Magazine*, December 2002.

DISCLAIMER

This report reflects the observations, findings, conclusions, and recommendations of the authors. The contents do not necessarily reflect the official views or policies of the California Department of Transportation or the State of California.

